

Application: Control temperature, humidity,

FY series controllers are microprocessor based controllers.

Which have been

Designed with high accuracy input, various output selection, useful options and good reliability at a competitive price.



Features

Various I/O Types

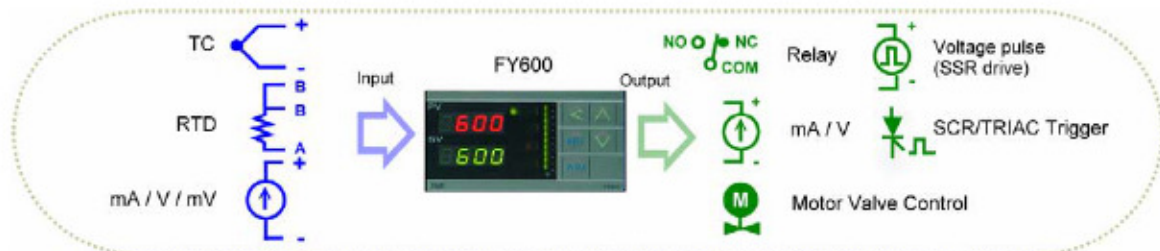

Peripheral Option

Remote SV

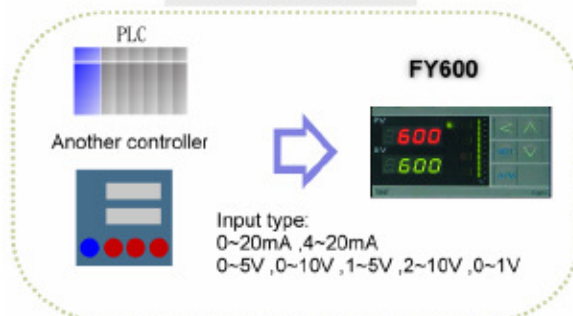

Transmission

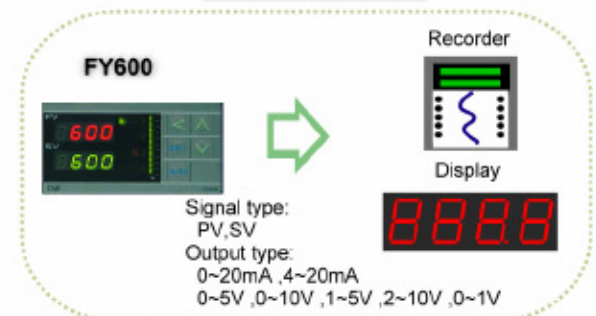

Communication

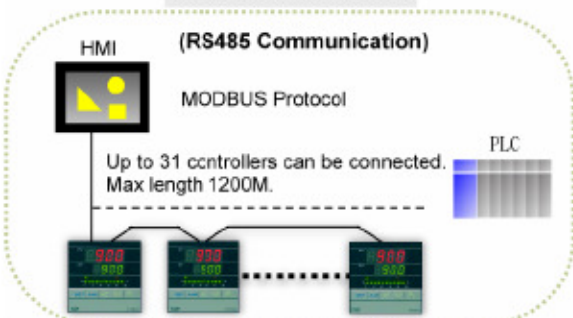

Communication

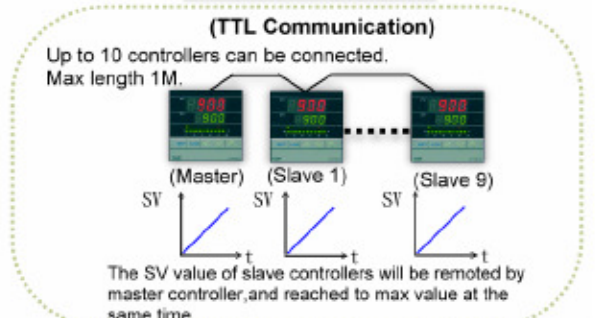

Specifications

- Standard spec.

Model	FY600	
Dimension	96X48mm	
Supply voltage	AC 85~265V · DC 15~50V (Option)	
Frequency	50 / 60 HZ	
Power consumption	approx 4VA	
Input	Accuracy	0.2 % FS \pm 1digit
	Sample time	250ms
	TC	K , J , R , S , B , E , N , T , W5Re/W26Re , PLII , U , L
	RTD	PT100,JPT100,JPT50
	mA dc	4~20mA , 0~20mA
	mV / V dc	0~1V,0~5V,0~10V,1~5V,2~10V -10~10mV,0~10mV,0~20mV,0~50mV,10~50mV
	Decimal point position	0000 , 000.0 , 00.00 , 0.000 Available for linear input (mA / mV / V)
Output 1	Relay	SPDT type 3A , 220V , electrical life:100,000 times or more (under rated load)
	Voltage pulse	For SSR drive. ON : 24V , OFF : 0V , max load current : 20mA
	mA dc	4~20mA, 0~20mA. Maximum load resistance:560 Ω
	Voltage dc	0~5V , 0~10V , 1~5V , 2~10V . Max load current:20mA
Alarm 1	3A , 220V , electrical life:100,000 times or more (under rated load)	
Control algorithm	PID , PI , PD , P , ON / OFF(P=0) , FUZZY ◦	
PID range	P: 0.0 ~ 200.0 % , I: 0~3600s , D: 0~900s	
Isolation	Output terminals(control output , alarm , transmission) and input terminals are isolated separately	
Isolated resistance	10M Ω or more between input and case (ground) at DC 500 V 10M Ω or more between output and case (ground) at DC 500 V	
Dielectric strength	1000V AC for 1 minute between input terminal and case (ground) 1500V AC for 1 minute between output terminal and case (ground)	
Operating temperature	0~50 $^{\circ}$ C	
Humidity range	20~90%RH	
Weight	225g	
Display Height	PV:7mm SV:7mm	

● **Optional Spec.**

Model	FY600
Output 2	For heating and cooling control use. Relay , SSR , 4~20mA , 0~20mA , 0~5V , 0~10V , 1~5V , 2~10V
Alarm 2	SPST type 3A , 220V , electrical life:100,000 times or more (under rated load)
Alarm 3	SPST type 3A , 220V , electrical life:100,000 times or more (under rated load)
Heater Break Alarm (HBA)	Display range of heater current : 0.0~99.9A , Accuracy : 1%FS Included CT : SC-80-T (5.8mm dia , 0.0~80.0A) or SC-100-T (12mm dia , 0.0~99.9A) Alarm relay : AL1
Transmission	Available for PV or SV transmission 4~20mA , 0~20mA , 0~1V , 0~5V , 0~10V , 1~5V , 2~10V
Remote SV	4~20mA , 0~20mA , 0~1V , 0~5V , 0~10V , 1~5V , 2~10V
Communication	Protocol : MODBUS RTU , MODBUS ASCII , TAIE RS232 , RS485 , TTL Baud rate: 2400 , 4800 , 9600 , 19200 , 38400 bps. Data bits : 8 , Stop bit : 1 or 2bit , Odd or Even parity.
Water/Dust proof	IP65

● **Special control output (OUT1)**

Model	FY600
3φ zero crossing control(3φSSR)	Available
Motor valve control	Available

● **Programmable RAMP/SOAK**

Model	PFY600
Programmable RAMP/SOAK	2 patterns with 8 segments each. The 2 patterns can be linked together as 16 segments use.

FY600 Terminals (96mm x 48mm , DIN 1/8)

A. Power Supply

AC 85~265V
DC 15 ~50V (Option)

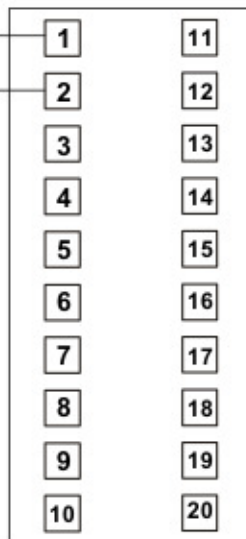

H. CT Input

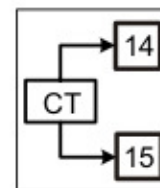

B. Control Output

OUT1

Relay SSR mA,V

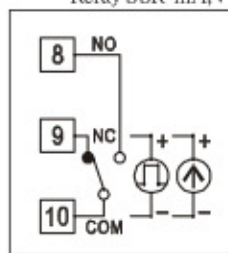

OUT2

Relay SSR mA,V

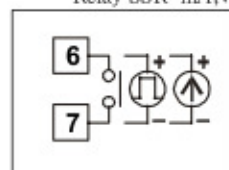

C. Input

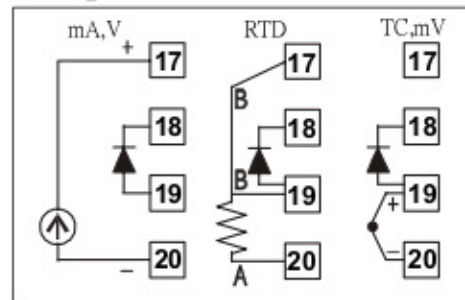

D. Alarm

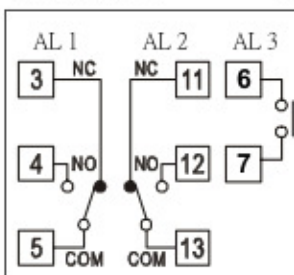

E. Transmission

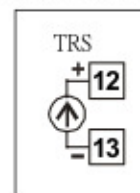

(Option)

OUT1 (Proportional Motor Valve Control)

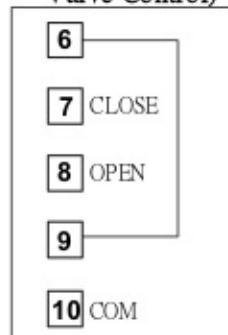

OUT1 (1 Φ Phase Angle Control)

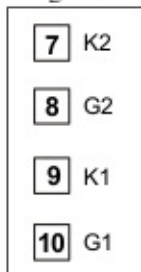

G. Communication

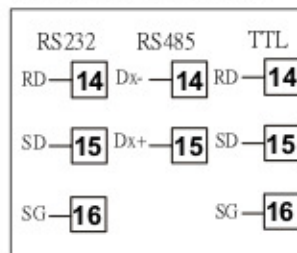

F. Remote

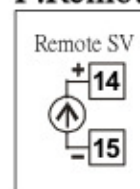

External dimension and panel cutout (Unit : mm)

FY600

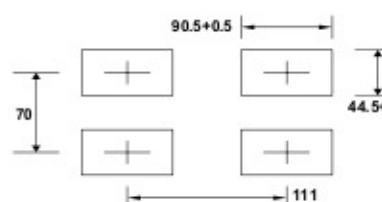
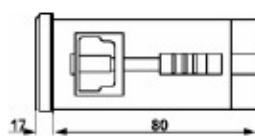

Parts description

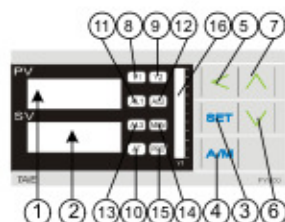

SYMBOL	NAME	FUNCTION
PV	① Measured value (PV) display	Displays PV or various parameter symbols (Red)
SV	② Set value (SV) display	Displays SV or various parameter set values (Green)
SET	③ Set key	Used for parameter calling up and set value registration
A/M	④ Auto/Manual key	Switches between Auto(PID) output mode and Manual output mode.
<	⑤ Shift key	Shift digits when settings are changed
∨	⑥ Down key *Program hold	Decrease numbers (-1000,-100,-10,-1) * Program hold (Programmable controller)
∧	⑦ Up key *Program run	Decrease numbers (+1000,+100,+10,+1) * Program run (Programmable controller)
OUT1	⑧ OUT1 lamp	Lights when OUT1 is activated (Green)
OUT2	⑨ OUT2 lamp	Lights when OUT2 is activated (Green) ◦
AT	⑩ Auto tuning lamp	Lights when Auto tuning is activated (Orange)
AL1	⑪ Alarm 1 lamp	Lights when Alarm 1 is activated (Red)
AL2	⑫ Alarm 2 lamp	Lights when Alarm 2 is activated (Red)
AL3	⑬ Alarm 3 lamp	Lights when Alarm 3 is activated (Red)
MAN	⑭ Manual output lamp	Lights when manual output is activated (Orange)
PRO	⑮ *Program running lamp	*Flashes when program is running (Programmable controller) ◦
OUT1%	⑯ OUT% bar-graph display	Output% is displayed on 10-dot LED.

Operations

Power On

Controller will display as below

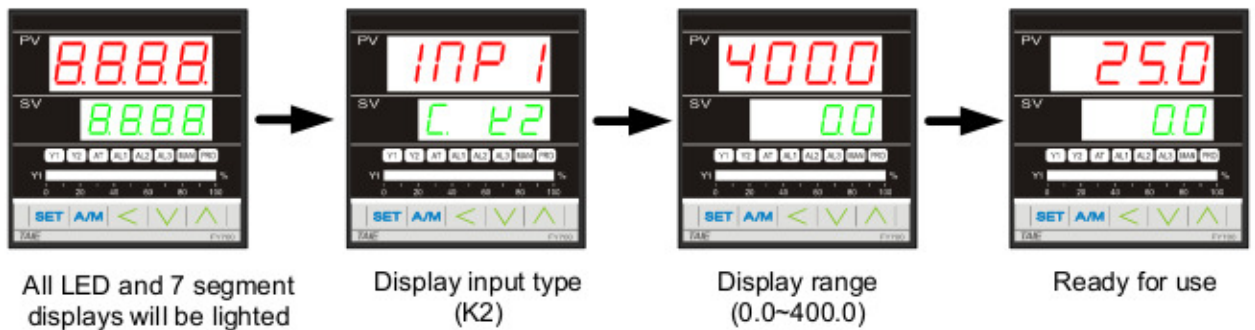

Change the Set Value (SV)

Change SV from 0.0 to 100.0

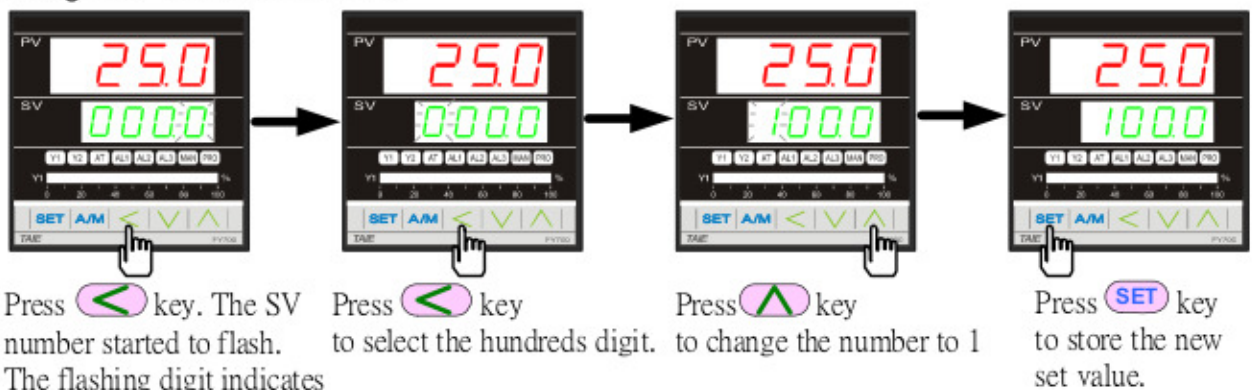

Change the Alarm Value

Change AL1 value to "5.0" (AL1 active, if PV exceeds SV over 5.0)

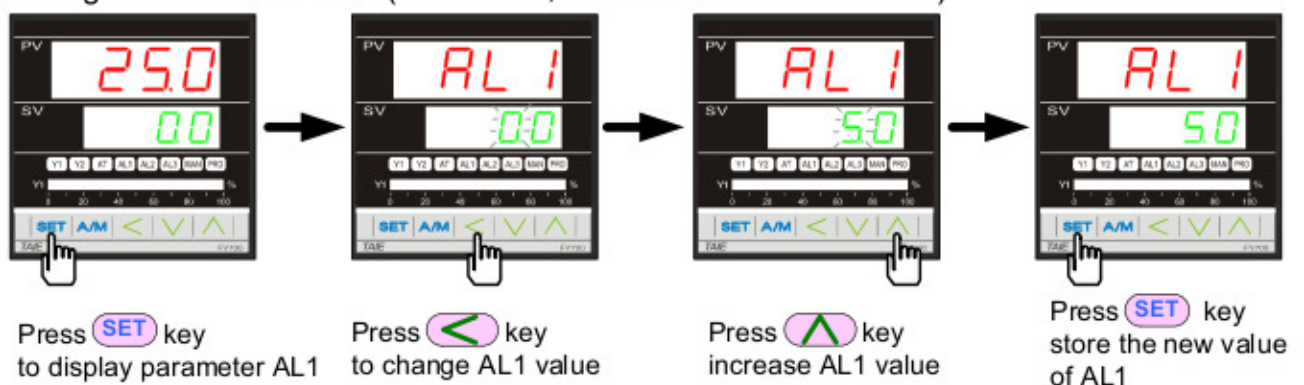

* There are total 16 alarm mode types, please refer with "alarm mode" in page 30

* To change alarm mode, press + key 5 seconds to enter Level 3 (Input Level) and then change ALD1/ALD2/ALD3 value.

Autotuning (AT)

Use AT function to automatically calculate and set the optimize PID value for your system.

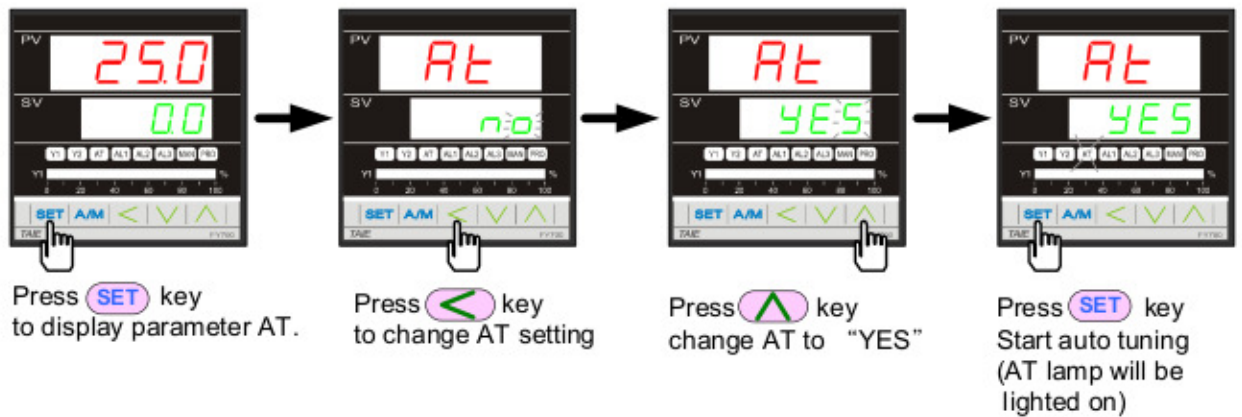

Autotuning ATVL=0

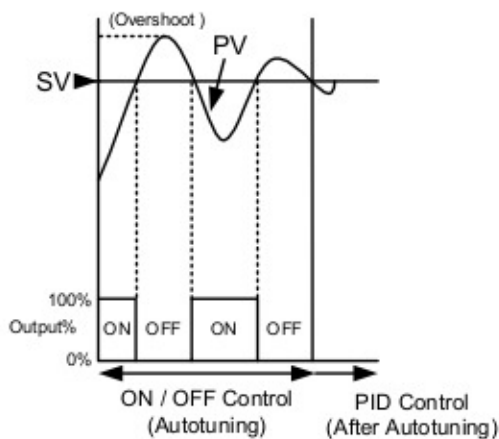

Autotuning ATVL=20

*Set ATVL to prevent overshoot occurred during autotuning process.

To set ATVL ,press **SET** key 5 seconds to enter Level 2 (PID Level) and then change the value.

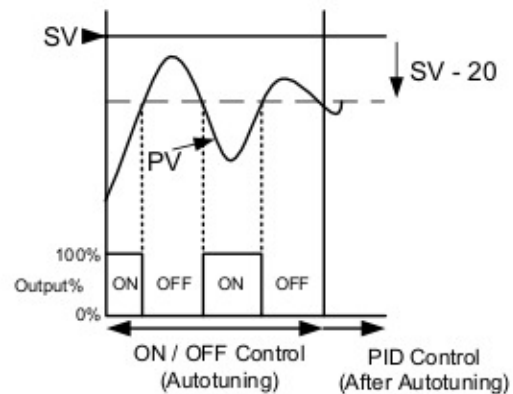

Autotuning failure

- Possible cause 1 : ATVL is too big. (If not sure , set ATVL=0)
- Possible cause 2 : Calculation time is too long. (Set PID parameter manually)

Programmable RAMP / SOAK (Only available for PFY model)

*For detail of the programmable instruction, please refer with page 25.

Assume the temperature profile is as below (use total 4 segments)

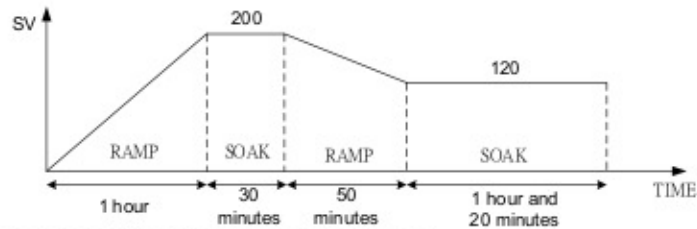

Please operate controller as following steps:

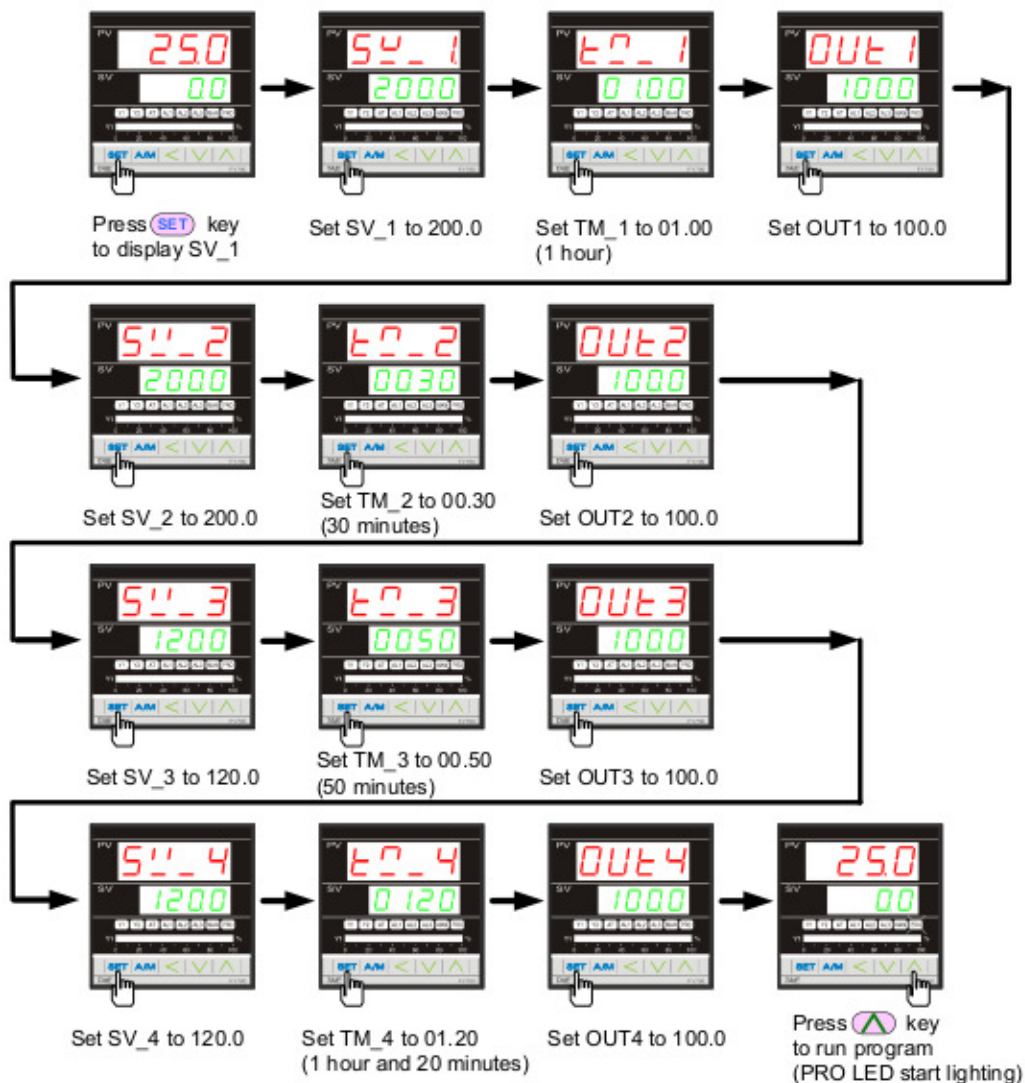

Operation levels

Levels diagram

